

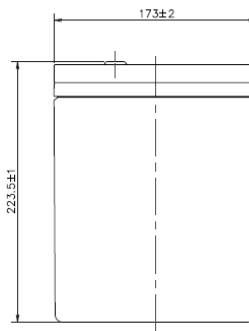

閥調式鉛酸蓄電池(VRLA)
Valve Regulated Lead Acid Battery

UXC90-12I FR

尺寸 DIMENSION

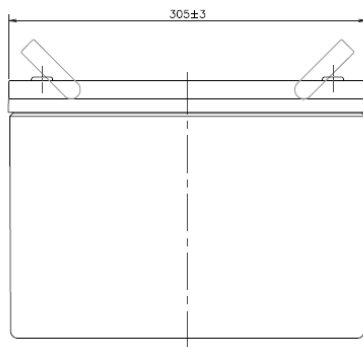
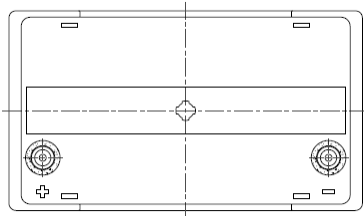

規範 Specification

- 公稱電壓 Nominal Voltage : 12V
- 操作溫度範圍 Operating Temperature Range
 - 放電 Discharging -15°C to 45°C
 - 充電 Charging -15°C to 45°C
 - 放置 Storage -15°C to 45°C
- 尺寸 Dimension
 - 長度 Length : 305±3mm
 - 寬度 Width : 173±2mm
 - 高度 Case Height : 220±2mm
 - 總高 Overall Height : 223.5±1mm
- 期待循環壽命 Expected Cycle life (25°C) : 50% DOD 600 Cycle
- 重量 Weight (約 Approx.) : 31.2 kg
- 容易保養 Easy Maintenance
 - 不會洩漏電解液 No electrolyte leakage
 - 確保操作上安全性 Ensure safe and efficient operation
- 公稱容量 Nominal Capacity : 90AH / 20HR (25°C)
- 防爆設計 Vent plug provided with built-in ceramic filter
 - 阻隔外部火源防止電池破裂 Prevent explosion from outside source of ignition
- 內部內阻 Internal Resistance(Approx.) : 約 3.5 mΩ
- 電槽材質 Container Material :
 - 難燃ABS Flame Retardant ABS · 難燃等級Flame class : UL94V0
 - 氧氣指數 Oxygen index : 28.0% LOI
- 最大充電電流 Max. Charge current : 22.5A
- 最大連續放電電流
 - Max. Continuous discharge current : 270A
- 把手設計 Handle Including
- 5 秒最大放電電流
 - Max. Discharge current in 5 seconds : 540A
- 用途 Applications :
 - 太陽能發電系統、電信、緊急照明、警報系統
 - Solar powered systems、Telecommunications、Emergency lighting、Alarm systems
- 浮動充電 Float Charging : 13.65±0.15V (25°C)
- 循環充電 Cycle Charging : 14.4~15.0V (25°C)
- 端子 Terminal :
 - 極柱端子Top terminal : 螺絲式 Bolt (M6)

UXC90-12I FR 性能規格 PERFORMANCE SPECIFICATION : 安培 Amperes and 瓦特 Watts at 25 °C (77 °F)

F.V.	TIME	5M	10M	15M	20M	30M	45M	1H	2H	3H	4H	5H	8H	10H	20H
10.80V	W	2949	2374	1955	1652	1227	913	734	413	295	236	192	129	101.1	54.4
	A	270	209	162	133	100	74	60.3	33.9	24.2	19.4	16.5	10.22	8.45	4.46
10.50V	W	3350	2592	2048	1698	1261	930	741	416	297	237	194	130	101.7	54.7
	A	306	232	176	143	106	77	60.9	34.1	24.4	19.5	16.6	10.28	8.51	4.50
10.20V	W	3629	2741	2119	1738	1291	947	750	420	300	240	195	132	102.4	54.9
	A	322	248	186	150	110	79	61.6	34.4	24.6	19.7	16.7	10.36	8.57	4.52
10.02V	W	3690	2806	2147	1753	1302	953	752	422	301	241	196	133	103	55.3
	A	326	251	188	152	111	80	61.8	34.6	24.7	19.8	16.8	10.40	8.60	4.54
9.60V	W	3856	2980	2223	1791	1331	967	759	426	304	243	199	134	104.3	56.1
	A	336	260	193	155	114	81	62.4	35.0	25.0	20.0	17.0	10.55	8.73	4.60

特性 Characteristics

溫度壽命特性 TEMPERATURE & LIFE CHARACTERISTICS

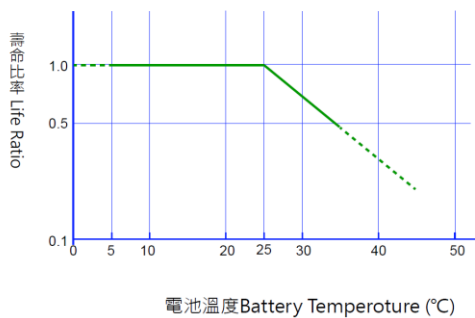

循環壽命特性 CYCLE LIFE CHARACTERISTICS

放電深度與循環壽命關係圖 Cycle Service Life in Relation to Depth of Discharge

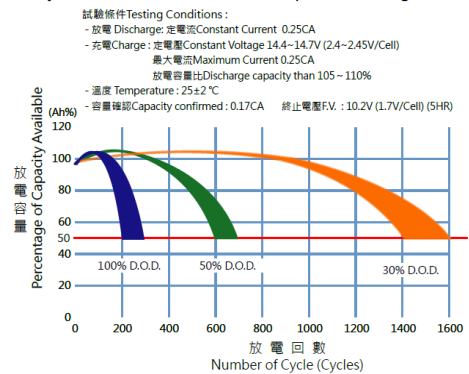

充電特性 CHARGE CHARACTERISTICS

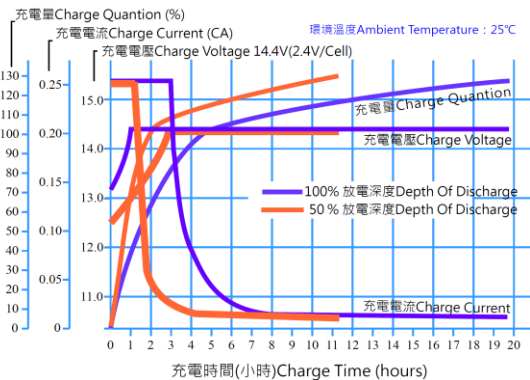

充電電壓 CHARGE VOLTAGE

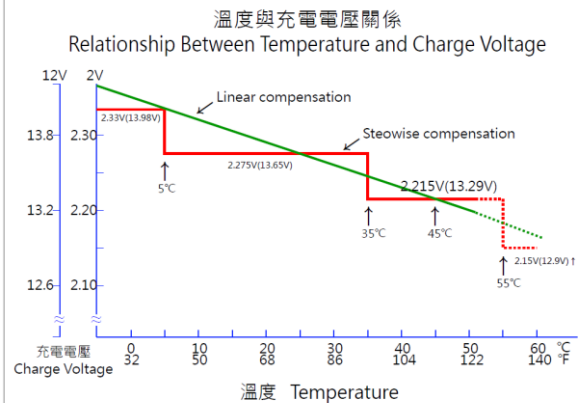

臺灣湯淺電池股份有限公司 新北市新莊區福營路 227 巷 11 號 TEL:(02)2901-8261 FAX:(02)2903-9626
 TAIWAN YUASA BATTERY CO.,LTD No.11, Ln. 227, Fuying Rd., Xinzhuang Dist., New Taipei City <http://www.yuasa.com.tw/>